

PRK 96

Retro-reflective photoelectric sensors with polarization filter

en 10-2013/05 50120810



**10m
24m**

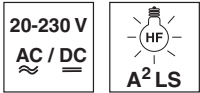

- Polarized retro-reflective photoelectric sensor with large operating range in visible red light
- Robust metal housing with glass cover or plastic housing, protection class IP 67 for industrial application
- All-mains design 20 ... 230VAC/DC with relay output
- Relay with change-over contact, sensitivity adjustment, delay before start-up and various options for optimal adaptation to the application
- Light/dark switching
- Connection via comfortable terminal compartment up to 1.5mm²



Accessories:

(available separately)

- Mounting systems (BT 96, BT 96.1, UMS 96, BT 450.1-96)
- Spark extinction
- Reflectors
- Reflective tapes

Dimensioned drawing

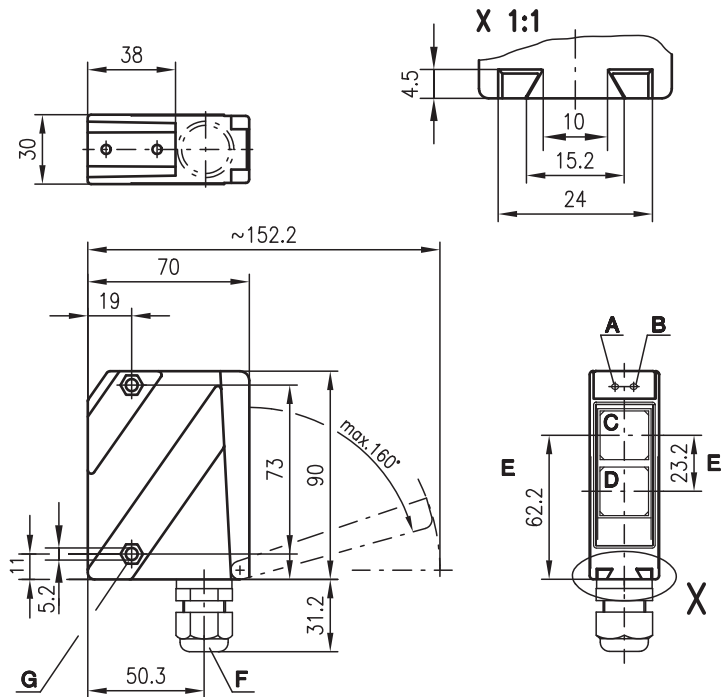

- A** Green indicator diode
- B** Yellow indicator diode
- C** Receiver
- D** Transmitter
- E** Optical axis
- F** Screwed cable gland M16x1.5 for Ø 5 ... 10mm
- G** Countersinking for SK nut M5, 4.2 deep
- H** Connection terminals
- I** Cable entry
- K** Sensitivity adjustment
- L** Light/dark switching

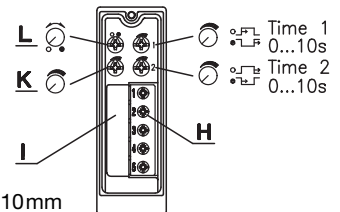

Electrical connection

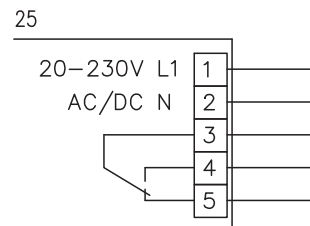

We reserve the right to make changes • DS_PRK96KR25_en_50120810.fm

Specifications

Optical data

Typ. op. range limit (TK(S) 100x100) ¹⁾	10m/24m
Operating range ²⁾	see tables
Light spot diameter	approx. 130mm at 6m
Light source	LED (modulated light)
Wavelength	660nm (visible red light, polarized)

Timing

Switching frequency	20Hz
Response time	25ms
Delay before start-up	≤ 200ms

Electrical data

Operating voltage U _B	20 ... 230VAC, 50/60Hz 20 ... 230VDC ± 10%
Power consumption	≤ 1.5VA
Switching output ³⁾	relay, 1 change-over contact
Function	break-contact/make-contact
Switching voltage, relay	250VAC/DC
Switching current, relay	250VAC, 3A/30VDC, 3A
Switching power, relay	750VA, cosφ=1
Sensitivity	adjustable

Indicators

Green LED	ready
Yellow LED	light path free
Yellow LED, flashing	light path free, no performance reserve

Mechanical data

Housing	polycarbonate
Optics cover	plastic
Weight	150g
Connection type	terminals

Environmental data

Ambient temp. (operation/storage)	-30°C ... +55°C/-40°C ... +55°C
Protective circuit ⁴⁾	1, 4
VDE safety class ⁵⁾	II, all-insulated
Protection class	IP 67
Light source	exempt group (in acc. with EN 62471)
Standards applied	IEC 60947-5-2

Options

Switching delay (slow oper./release)	0 ... 10s (separately adjustable)
--------------------------------------	-----------------------------------

- 1) Typ. operating range limit: max. attainable range without performance reserve
- 2) Operating range: recommended range with performance reserve
- 3) Suitable spark extinction must be provided with inductive or capacitive loads
- 4) 1=transient protection, 4=interference blanking
- 5) Rating voltage 250VAC

● Approved purpose:

This product may only be used by qualified personnel and must only be used for the approved purpose. This sensor is not a safety sensor and is not to be used for the protection of persons.

Order guide

Selection table		Order code →								
Equipment ↓		PRK 96K/R-1420-25 Part no. 50025167	PRK 96K/R-1430-25 Part no. 50025168	PRK 96K/R-3428-25 Part no. 50035351	PRK 96K/R-3428.1-25 Part no. 50107216	PRK 96K/R-1420.1-25 Part no. 50106587				
Housing	metal									
	plastic	●	●	●	●	●				
Light source	red light (8m)	●	●			●				
	red light (15m)									
	red light (20m)			●	●					
Connection	terminals	●	●	●	●	●				
	M12 connector									
Features	light/dark switching				●	●				
	optics heating/low temp.									
	switching delay		●							

Tables

10m models

Reflectors	Operating range
1 TK(S) 100x100	0.3 ... 8m
2 MTK(S) 50x50	0.3 ... 7m
3 TK(S) 30x50	0.3 ... 4.5m
4 TK(S) 20x40	0.3 ... 3m
5 TK(S) 82	0.3 ... 6m

1	0.1	8	10
2	0.1	7	8.5
3	0.1	4.5	5
4	0.1	3	4
5	0.1	6	7.5

24m models

Reflectors	Operating range
1 TK(S) 100x100	0.3 ... 20m
2 MTK(S) 50x50	0.3 ... 15m
3 TK(S) 30x50	0.3 ... 10m
4 TK(S) 20x40	0.3 ... 8m
5 TK(S) 82	0.3 ... 15m

1	0.1	20	24
2	0.1	15	16
3	0.1	10	12
4	0.1	8	9
5	0.1	15	17

- Operating range [m]
- Typ. operating range limit [m]

Diagrams

10m (8m) models

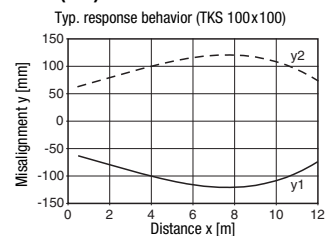

24m (20m) models

